

dlh pointman series specifications

materials:

All wood is thoroughly air and kiln dried to a moisture content not to exceed 8% at the time of assembly.

veneers:

All exposed surfaces are plain sliced Cherry, American Black Walnut or White Maple Veneer. Walnut veneers are carefully book-matched. Cherry and Maple veneers are slip-matched. All drawer fronts, doors, end panels, and modesty panels are vertical grain.

top work surfaces:

Laminate tops are 1 1/4" thick, 3-ply construction; consisting of a high-pressure laminate work surface and a 45 lb density flake board core. The under side of the top has a smooth surface Gator-Ply backing sheet. Top rims are 3/4" hardwood with a choice of top edge shape on all four sides.

modesty panels:

3/4" thick, 3-ply construction with a vertical book matched veneer on exposed surfaces and a 45 lb density flake board core. Desk modesty panels are full to the floor.

construction:

Uses a mortise & tenon and glue to join panels and modesty panels. All joints are reinforced with glue blocks. Each desk pedestal has an easy slide out dictation arm/mousing slide mounted above the drawers for more work surface area. All pedestals have a side route finger drawer pulls.

drawers:

Drawer fronts are 3/4" thick, 3-ply construction with vertical book matched veneer. Drawer edges are veneered on top and sides with matching wood veneers. All drawer sides and backs are plywood, dovetailed front and back with 3-ply drawer bottoms. Drawer bottoms are framed on four sides and stapled from the bottom side. Drawer interiors are finished with a clear coat sealer to prevent swelling or shrinkage. Box drawers have a high grade Sterling metal ball-bearing drawer suspension. File drawers have a high grade Sterling metal ball bearing full progressive suspension and are equipped with metal rods for hanging file folders. All drawers have smooth quiet operation.

locking:

Each pedestal has its own lock and is keyed alike for each unit. Each unit is equipped with two keys. Units may be keyed alike in groups (per office, if requested) for an additional charge of \$11.78 net per unit.

finish:

All Inwood finishes are catalyzed varnish and have excellent durability. Our multi-step satin finishes leave a beautiful natural look to the furniture, and are available in the following finishes: (3L) walnut, (2KL) walnut, (25M) mahogany, (4L) dark mahogany, (25C) cherry, (2ML) natural maple, (3ML) light maple, (4ML) medium maple, (5ML) cherry finish on maple, (6LC) Light Cherry, (7MC) Medium Cherry, (8DC) Dark Cherry, (9BC) Burgundy Cherry, (25B) Ebony.

dlh pointman lift system:

The lift system is driven by two linear actuators, which have 180 lbs of thrust each. These are powered by a 120 volt electric control box which supplies a smooth quiet travel at 1.5"/second. The lift system is located in the kneespace area and is secured by a lockable hinged access panel. The control switch is secured inside the CPU pedestal. With the touch of a button, the DLH Pointman Organizer ascends from the unit to reveal the storage compartment. Another touch of a button descends the DLH Pointman back into the unit. The down stroke has an anti-collision function which will stop the descent if there is an obstruction.

dlh pointman series dimensions

36" x 72" desks:

center bay inside dimensions8 1/4"d x 17 1/2"h x 47 5/16"w
left/right bay area dimensions.....8 1/4"d x 17 1/2"h x 6 1/4"w
height of unit when fully open.....19 1/2"h
overall height when fully open48 1/2"h

36" x 66" desks:

center bay inside dimensions8 1/4"d x 17 1/2"h x 41 5/16"w
left/right bay area dimensions.....8 1/4"d x 17 1/2"h x 6 1/4"w
height of unit when fully open.....19 1/2"h
overall height when fully open48 1/2"h

30" x 66" desks:

center bay inside dimensions8 1/4"d x 17 1/2"h x 25 3/4"w
left/right bay area dimensions.....open
height of unit when fully open.....19 1/2"h
overall height when fully open48 1/2"h

72" wide credenzas:

center bay inside dimensions8 1/4"d x 17 1/2"h x 31 3/4"w
left/right bay area dimensions.....open
height of unit when fully open.....19 1/2"h
overall height when fully open48 1/2"h

66" wide credenzas:

center bay inside dimensions8 1/4"d x 17 1/2"h x 25 3/4"w
left/right bay area dimensions.....open
height of unit when fully open.....19 1/2"h
overall height when fully open48 1/2"h

dlh pointman additions







contact the customs department to inquire about installing the DLH Pointman Organizer in other Inwood units.

dlh pointman

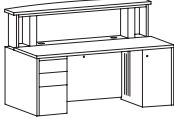
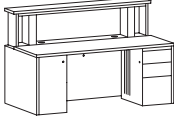
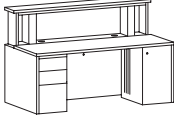
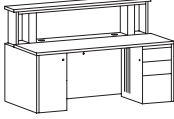
| wood top, veneer chassis, veneer drawer fronts
| laminate top, veneer chassis, veneer drawer fronts

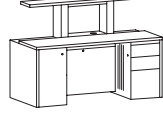

dlh pointman
2300/2100

	model number	description	d w h	freight	net \$ zone 1	net \$ zone 2
	PDFBT2372RCFP- ___ - - - - PDFBT2172RCFP- ___ - - - -	double pedestal bow front desk left box/box/file pedestal right cpu pedestal	42 72 29 <i>APPROACH: 6"</i> <i>KNEESPACE: 40"</i>	class 125 cwt 455 lb cu ft 55	2,218.67 W 1,996.03 P	2,361.09 W 2,179.66 P
	PDFBT2372LCFP- ___ - - - - PDFBT2172LCFP- ___ - - - -	double pedestal bow front desk left cpu pedestal right box/box/file pedestal	42 72 29 <i>APPROACH: 6"</i> <i>KNEESPACE: 40"</i>	class 125 cwt 455 lb cu ft 55	2,218.67 W 1,996.03 P	2,361.09 W 2,179.66 P
	PDF2372RCFP- ___ - - - - PDF2172RCFP- ___ - - - -	double pedestal desk left box/box/file pedestal right cpu pedestal	36 72 29 <i>KNEESPACE: 40"</i>	class 125 cwt 450 lb cu ft 53	1,635.55 W 1,506.59 P	1,729.97 W 1,594.54 P
	PDF2372LCFP- ___ - - - - PDF2172LCFP- ___ - - - -	double pedestal desk left cpu pedestal right box/box/file pedestal	36 72 29 <i>KNEESPACE: 40"</i>	class 125 cwt 450 lb cu ft 53	1,635.55 W 1,506.59 P	1,729.97 W 1,594.54 P
	PDF2366RCFP- ___ - - - - PDF2166RCFP- ___ - - - -	double pedestal desk left box/box/file pedestal right cpu pedestal	36 66 29 <i>KNEESPACE: 34"</i>	class 125 cwt 420lb cu ft 48	1,601.17 W 1,494.45 P	1,696.11 W 1,580.93 P
	PDF2366LCFP- ___ - - - - PDF2166LCFP- ___ - - - -	double pedestal desk left cpu pedestal right box/box/file pedestal	36 66 29 <i>KNEESPACE: 34"</i>	class 125 cwt 420lb cu ft 48	1,601.17 W 1,494.45 P	1,696.11 W 1,580.93 P
	PDF236630RCFP- ___ - - - - PDF216630RCFP- ___ - - - -	double pedestal desk left box/box/file pedestal right cpu pedestal	30 66 29 <i>KNEESPACE: 34"</i>	class 125 cwt 405 lb cu ft 40	1,462.80 W 1,434.83 P	1,547.44 W 1,517.26 P
	PDF236630LCFP- ___ - - - - PDF216630LCFP- ___ - - - -	double pedestal desk left cpu pedestal right box/box/file pedestal	30 66 29 <i>KNEESPACE: 34"</i>	class 125 cwt 405 lb cu ft 40	1,462.80 W 1,434.83 P	1,547.44 W 1,517.26 P
	PCCR237224RCFP - - - - - PCCR217224RCFP - - - - -	kneespace credenza left file/file pedestal right cpu pedestal	24 72 29 <i>KNEESPACE: 31.5"</i>	class 125 cwt 355 lb cu ft 34	1,394.72 W 1,357.55 P	1,519.10 W 1,475.31 P





laminated
tops only

3L-P walnut
4L-P dark mahogany on walnut
25M-P mahogany on walnut
25C-P cherry on walnut
25B-P ebony on walnut
2ML-P natural maple
3ML-P light maple
4ML-P medium maple
5ML-P cherry on maple
6LC-P light cherry on cherry
7MC-P medium cherry on cherry
8DC-P dark cherry on cherry

veneers
top and
chassis
finish

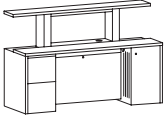
3L-W walnut
2KL-W walnut
4L-W dark mahogany on walnut
25M-W mahogany on walnut
25B-W ebony on walnut
25C-W cherry on walnut
2ML-W natural maple
3ML-W light maple
4ML-W medium maple
5ML-W cherry on maple
6LC-W light cherry on cherry

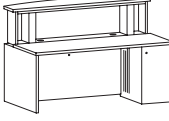
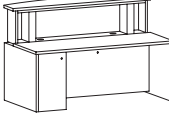
7MC-W medium cherry on cherry
8DC-W dark cherry on cherry
9BC-W burgundy cherry on cherry

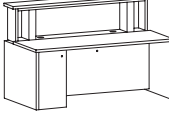
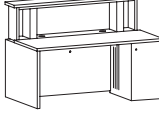
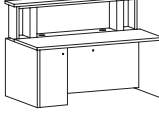
	model number	description	d w h	freight	net \$ zone 1	net \$ zone 2
	PCCR237224LCFP- - - - -	kneespace credenza left file/file pedestal right cpu pedestal	24 72 29 <i>KNEESPACE: 31.5"</i>	class 125 cwt 355 lb cu ft 34	1,394.72 W	1,519.10 W
	PCCR217224LCFP- - - - -				1,357.55 P	1,475.31 P
	PCCR236624RCFP- - - - -	kneespace credenza right file/file pedestal left cpu pedestal	24 66 29 <i>KNEESPACE: 25.5"</i>	class 125 cwt 340 lb cu ft 30	1,394.82 W	1,440.72 W
	PCCR216624RCFP- - - - -				1,328.85 P	1,429.31 P
	PCCR236624LCFP- - - - -	kneespace credenza left cpu pedestal right file/file pedestal	24 66 29 <i>KNEESPACE: 25.5"</i>	class 125 cwt 340 lb cu ft 30	1,394.82 W	1,440.72 W
	PCCR216624LCFP- - - - -				1,328.85 P	1,429.31 P
	PDDBT2372RCFP- _ - - - -	bow front single pedestal desk right cpu pedestal	42 72 29 <i>APPROACH: 6"</i>	class 125 cwt 380 lb cu ft 55	1,985.73 W	2,111.95 W
	PDDBT2172RCFP- _ - - - -				1,745.06 P	1,852.14 P
	PDDBT2372LCFP- _ - - - -	bow front single pedestal desk left cpu pedestal	42 72 29 <i>APPROACH: 6"</i>	class 125 cwt 380 lb cu ft 55	1,985.73 W	2,111.95 W
	PDDBT2172LCFP- _ - - - -				1,745.06 P	1,852.14 P
	PDD2372RCFP- _ - - - -	single pedestal desk right cpu pedestal	36 72 29	class 125 cwt 375 lb cu ft 53	1,450.66 W	1,533.82 W
	PDD2172RCFP- _ - - - -				1,255.98 P	1,323.70 P
	PDD2372LCFP- _ - - - -	single pedestal desk left cpu pedestal	36 72 29	class 125 cwt 375 lb cu ft 53	1,450.66 W	1,533.82 W
	PDD2172LCFP- _ - - - -				1,255.98 P	1,323.70 P
	PDD2366RCFP- _ - - - -	single pedestal desk right cpu pedestal	36 66 29	class 125 cwt 350 lb cu ft 48	1,391.04 W	1,469.06 W
	PDD2166RCFP- _ - - - -				1,246.78 P	1,313.76 P
	PDD2366LCFP- _ - - - -	single pedestal desk left cpu pedestal	36 66 29	class 125 cwt 350 lb cu ft 48	1,391.04 W	1,469.06 W
	PDD2166LCFP- _ - - - -				1,246.78 P	1,313.76 P

top
P laminate top
W veneer top

edge





	model number	description	d	w	h	freight	net \$ zone 1	net \$ zone 2
	PDD236630RCFP- - - -	single pedestal desk right cpu pedestal	30	66	29	class 125 cwt 340 lb cu ft 40	1,342.83 W	1,417.90 W
	PDD216630RCFP- - - -						1,106.94 P	1,162.14 P
	PDD236630LCFP- - - -	single pedestal desk left cpu pedestal	30	66	29	class 125 cwt 340 lb cu ft 40	1,342.83 W	1,417.90 W
	PDD216630LCFP- - - -						1,106.94 P	1,162.14 P
	PCC2372RCFP- - - -	single pedestal credenza right cpu pedestal	24	72	29	class 125 cwt 150 lb cu ft 28	1,191.58 W	1,253.78 W
	PCC2172RCFP- - - -						1,093.70 P	1,148.53 P
	PCC2372LCFP- - - -	single pedestal credenza left cpu pedestal	24	72	29	class 125 cwt 150 lb cu ft 28	1,191.58 W	1,253.78 W
	PCC2172LCFP- - - -						1,093.70 P	1,148.53 P
	PCC2366RCFP- - - -	single pedestal credenza right cpu pedestal	24	66	29	class 125 cwt 150 lb cu ft 26	1,131.97 W	1,190.11 W
	PCC2166RCFP- - - -						1,035.55 P	1,085.60 P
	PCC2366LCFP- - - -	single pedestal credenza left cpu pedestal	24	66	29	class 125 cwt 150 lb cu ft 26	1,131.97 W	1,190.11 W
	PCC2166LCFP- - - -						1,035.55 P	1,085.60 P

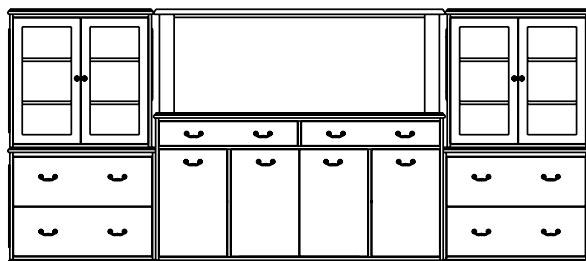

point unit	d	w	h
	24	144	63
pointman unit only	d	w	h
	6	61.9	25.9

freight	net \$ zone 1	net \$ zone 2
class 125 cwt 935 lb cu ft 110	4,680.59 W	5,053.01 W
	4,360.43 P	4,707.46 P

*SEE PAGE 352 FOR POINT UNIT BREAKDOWN

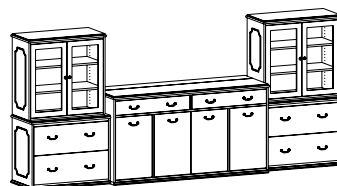

Price is "total unit"

laminated
tops only

- 3L-P walnut
- 4L-P dark mahogany on walnut
- 25M-P mahogany on walnut
- 25C-P cherry on walnut
- 25B-P ebony on walnut
- 2ML-P natural maple
- 3ML-P light maple
- 4ML-P medium maple
- 5ML-P cherry on maple
- 6LC-P light cherry on cherry
- 7MC-P medium cherry on cherry
- 8DC-P dark cherry on cherry

veneered
top and
chassis
finish

- 3L-W walnut
- 2KL-W walnut
- 4L-W dark mahogany on walnut
- 25M-W mahogany on walnut
- 25B-W ebony on walnut
- 25C-W cherry on walnut
- 2ML-W natural maple
- 3ML-W light maple
- 4ML-W medium maple
- 5ML-W cherry on maple
- 6LC-W light cherry on cherry

- 7MC-W medium cherry on cherry
- 8DC-W dark cherry on cherry
- 9BC-W burgundy cherry on cherry

PDFBT2372RCFP-3L-W-A

unit identification (type), top dimension, chassis option - **chassis & top finish - top material - edge trim**

dlh_pointman
2300/2100

model number	description	d	w	h	freight	net \$ zone 1	net \$ zone 2
PDMBT2372RC-EHFP	executive "I" unit	90	72	29	class 125 cwt 555 lb cu ft 76	2,551.34 W	2,723.60 W
PDMBT2172RC-EHFP						2,221.62 P	2,366.61 P

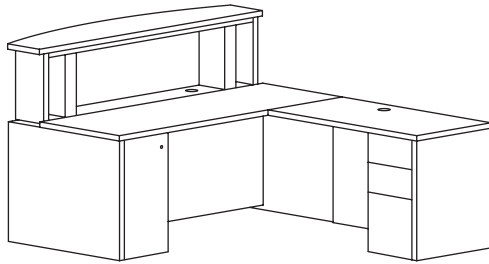

consists of:	d	w	h	quantity
PDDBT2372LCFP/PDDBT2172LCFP bow front single pedestal desk left cpu pedestal	42	72	29	1
	APPROACH: 6" KNEESPACE: 32"			
R2348R-EHFP/R2148R-EHFP single pedestal return right box/box/file pedestal	24	48	29	1
	KNEESPACE: 32"			

model number	description	d	w	h	freight	net \$ zone 1	net \$ zone 2
PDMBT2372LC-EHFP	executive "I" unit	90	72	29	class 125 cwt 555 lb cu ft 76	2,551.34 W	2,723.60 W
PDMBT2172LC-EHFP						2,221.62 P	2,366.61 P

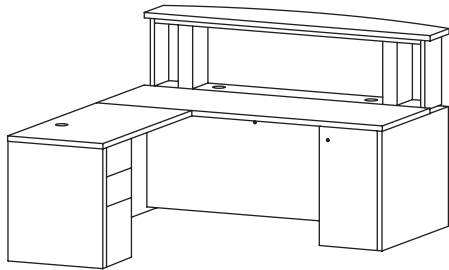

consists of:	d	w	h	quantity
PDDBT2372RCFP/PDDBT2172RCFP bow front single pedestal desk right cpu pedestal	42	72	29	1
	APPROACH: 6" KNEESPACE: 32"			
R2348L-EHFP/R2148L-EHFP single pedestal return left box/box/file pedestal	24	48	29	1
	KNEESPACE: 32"			

model number	description	d	w	h	freight	net \$ zone 1	net \$ zone 2
PDM2372RC-EHFP	executive "I" unit	84	72	29	class 125 cwt 550 lb cu ft 74	2,016.27 W	2,145.07 W
PDM2172RC-EHFP						1,732.54 P	1,838.53 P

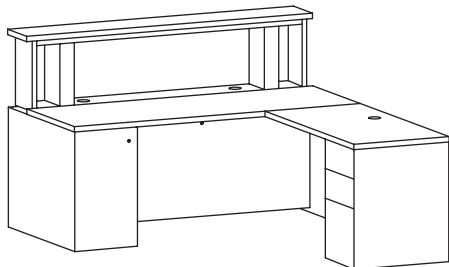

consists of:	d	w	h	quantity
PDD2372LCFP/PDD2172LCFP single pedestal desk left cpu pedestal	36	72	29	1
	KNEESPACE: 32"			
R2348R-EHFP/R2148R-EHFP single pedestal return right box/box/file pedestal	24	48	29	1
	KNEESPACE: 32"			

top P laminate top veneer top **returns** custom length return sizes are available up to 65" with the grain direction running lengthwise (opposite the desk grain), add \$150.88 net and specify length.

edge





model number	description	d	w	h	freight	net \$ zone 1	net \$ zone 2
PDM2372LC-EHFP-__	executive "I" unit	84	72	29	class 125 cwt 550 lb cu ft 74	2,016.27 W	2,145.07 W
PDM2172LC-EHFP-__						1,732.54 P	1,838.53 P

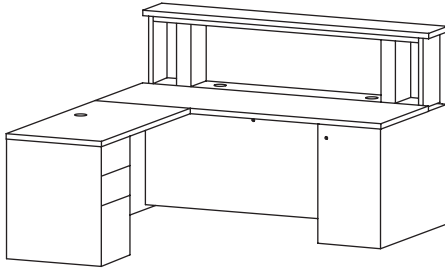

consists of:		d	w	h	quantity
PDD2372RCFP/PDD2172RCFP	single pedestal desk right cpu pedestal	36	72	29	1 <i>KNEESPACE: 32"</i>
R2348L-EHFP/R2148L-EHFP	single pedestal return left box/box/file pedestal	24	48	29	1 <i>KNEESPACE: 32"</i>

model number	description	d	w	h	freight	net \$ zone 1	net \$ zone 2
PDM2366RC-EHFP-__	executive "I" unit	84	66	29	class 125 cwt 530 lb cu ft 71	1,957.02 W	2,079.94 W
PDM2166RC-EHFP-__						1,723.34 P	1,828.59 P

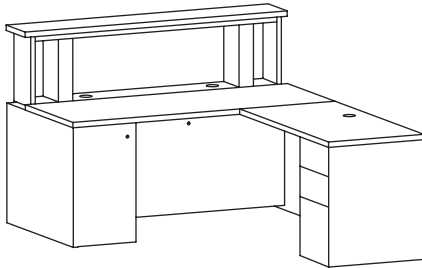

consists of:		d	w	h	quantity
PDD2366LCFP/PDD2166LCFP	single pedestal desk left cpu pedestal	36	66	29	1 <i>KNEESPACE: 26"</i>
R2348R-EHFP/R2148R-EHFP	single pedestal return right box/box/file pedestal	24	48	29	1 <i>KNEESPACE: 32"</i>

model number	description	d	w	h	freight	net \$ zone 1	net \$ zone 2
PDM2366LC-EHFP-__	executive "I" unit	84	66	29	class 125 cwt 530 lb cu ft 71	1,957.02 W	2,079.94 W
PDM2166LC-EHFP-__						1,723.34 P	1,828.59 P

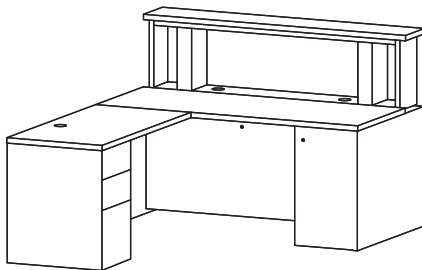

consists of:		d	w	h	quantity
PDD2366RCFP/PDD2166RCFP	single pedestal desk right cpu pedestal	36	66	29	1 <i>KNEESPACE: 26"</i>
R2348L-EHFP/R2148L-EHFP	single pedestal return left box/box/file pedestal	24	48	29	1 <i>KNEESPACE: 32"</i>

laminates	tops only
3L-P	walnut
4L-P	dark mahogany on walnut
25M-P	dark mahogany on walnut
25C-P	cherry on walnut
25B-P	ebony on walnut
2ML-P	natural maple
3ML-P	light maple
4ML-P	medium maple
5ML-P	cherry on maple
6LC-P	light cherry on cherry
7MC-P	medium cherry on cherry
8DC-P	dark cherry on cherry

veneers	top and chassis finish
3L-W	walnut
2KL-W	walnut
4L-W	dark mahogany on walnut
25M-W	dark mahogany on walnut
25B-W	ebony on walnut
25C-W	cherry on walnut
2ML-W	natural maple
3ML-W	light maple
4ML-W	medium maple
5ML-W	cherry on maple
6LC-W	light cherry on cherry

7MC-W	medium cherry on cherry
8DC-W	dark cherry on cherry
9BC-W	burgundy cherry on cherry

model number	description	d	w	h	freight	net \$ zone 1	net \$ zone 2
PDM236630RC-EHFP	executive "I" unit	78	66	29	class 125 cwt 525 lb cu ft 640	1,908.45 W	2,029.15 W
PDM216630RC-EHFP						1,583.87 P	1,677.34 P

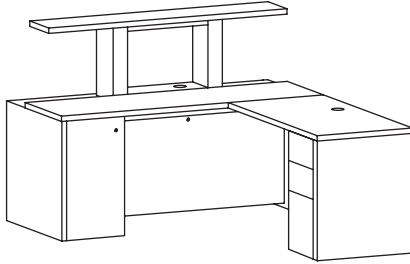

consists of:	d	w	h	quantity
PDD236630LCFP/PDD216630LCFP single pedestal desk left cpu pedestal	30	66	29	1
R2348R-EHFP/R2148R-EHFP single pedestal return right box/box/file pedestal	24	48	29	1

model number	description	d	w	h	freight	net \$ zone 1	net \$ zone 2
PDM236630LC-EHFP	executive "I" unit	78	66	29	class 125 cwt 525 lb cu ft 640	1,908.45 W	2,029.15 W
PDM216630LC-EHFP						1,583.87 P	1,677.34 P

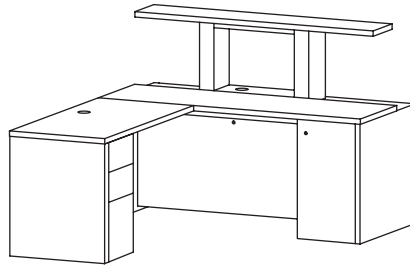

consists of:	d	w	h	quantity
PDD236630RCFP/PDD216630RCFP single pedestal desk right cpu pedestal	30	66	29	1
R2348L-EHFP/R2148L-EHFP single pedestal return left box/box/file pedestal	24	48	29	1

model number	description	d	w	h	freight	net \$ zone 1	net \$ zone 2
PDUMBT2372RC-EHFP	executive bow front "u" unit	110	72	29	class 125 cwt 670 lb cu ft 84	3,112.54 W	3,328.19 W
PDUMBT2172RC-EHFP						2,615.74 P	2,792.75 P

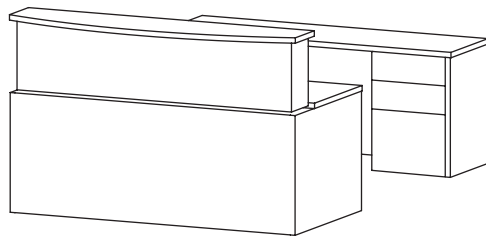

consists of:	d	w	h	quantity
PDDBT2372LCFP/PDDBT2172LCFP bow front single pedestal desk left cpu pedestal	42	72	29	1
B2348-EH/B2148-EH bridge with open kneespace	20	48	29	1
C2372R-FP/C2172R-FP single pedestal credenza right box/box/file pedestal	20	72	29	1

top **P** laminate top
W veneer top

bridges custom length return and bridge sizes are available up to 65" with the grain direction running lengthwise (opposite the desk grain), add \$150.88 net and specify length.

edge





model number	description	d	w	h	freight	net \$ zone 1	net \$ zone 2
PDUMBT2372LC-EHFP	executive "u" unit	110	72	29	class 125	3,112.54 W	3,328.19 W
-----					cwt 670 lb		
PDUMBT2172LC-EHFP					cu ft 84	2,615.74 P	2,792.75 P

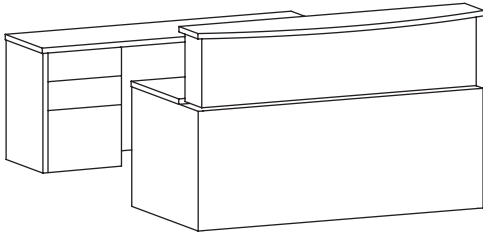

consists of:		d	w	h	quantity
PDDBT2372RCFP/PDDBT2172RCFP bow front single pedestal desk right cpu pedestal		42	72	29	1
		APPROACH: 6"			
		KNEESPACE: 36"			
B2348-EH/B2148-EH bridge with open kneespace		20	48	29	1
		KNEESPACE: 48"			
C2372L-FP/C2172L-FP single pedestal credenza left box/box/file pedestal		20	72	29	1
		KNEESPACE: 32"			

model number	description	d	w	h	freight	net \$ zone 1	net \$ zone 2
PCUMBT2372RC-EHFP	executive "u" unit	110	72	29	class 125	3,112.54 W	3,328.19 W
-----					cwt 670 lb		
PCUMBT2172RC-EHFP					cu ft 84	2,615.74 P	2,792.75 P

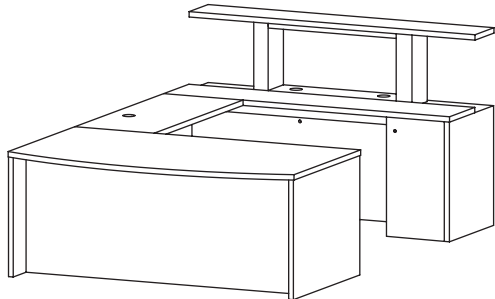

consists of:		d	w	h	quantity
DBT2372L-FP/DBT2172L-FP bow front single pedestal desk left file/file pedestal		42	72	29	1
		APPROACH: 13"			
		KNEESPACE: 36"			
B2348-EH/B2148-EH bridge with open kneespace		20	48	29	1
		KNEESPACE: 48"			
PCC2372RCFP/PCC2172RCFP single pedestal credenza right cpu pedestal		20	72	29	1
		KNEESPACE: 32"			

model number	description	d	w	h	freight	net \$ zone 1	net \$ zone 2
PCUMBT2372LC-EHFP	executive "u" unit	110	72	29	class 125	3,112.54 W	3,328.19 W
-----					cwt 670 lb		
PCUMBT2172LC-EHFP					cu ft 84	2,615.74 P	2,792.75 P

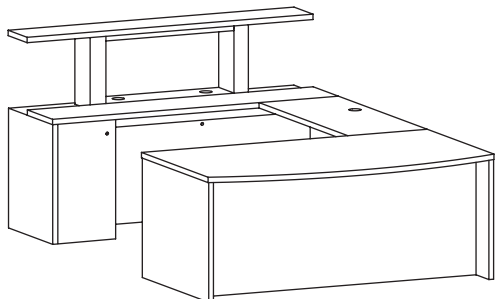

consists of:		d	w	h	quantity
DBT2372R-FP/DBT2172R-FP bow front single pedestal desk right file/file pedestal		42	72	29	1
		APPROACH: 13"			
		KNEESPACE: 36"			
B2348-EH/B2148-EH bridge with open kneespace		20	48	29	1
		KNEESPACE: 48"			
PCC2372LCFP/PCC2172LCFP single pedestal credenza left cpu pedestal		20	72	29	1
		KNEESPACE: 32"			

laminates tops only		veneer top and chassis finish
3L-P	walnut	
4L-P	dark mahogany on walnut	
25M-P	mahogany on walnut	
25C-P	cherry on walnut	
25B-P	ebony on walnut	
2ML-P	natural maple	
3ML-P	light maple	
4ML-P	medium maple	
5ML-P	cherry on maple	
6LC-P	light cherry on cherry	
7MC-P	medium cherry on cherry	
8DC-P	dark cherry on cherry	

3L-W	walnut
2KL-W	walnut
4L-W	dark mahogany on walnut
25M-W	mahogany on walnut
25B-W	ebony on walnut
25C-W	cherry on walnut
2ML-W	natural maple
3ML-W	light maple
4ML-W	medium maple
5ML-W	cherry on maple
6LC-W	light cherry on cherry

7MC-W	medium cherry on cherry
8DC-W	dark cherry on cherry
9BC-W	burgundy cherry on cherry

model number	description	d	w	h	freight	net \$ zone 1	net \$ zone 2
PDUM2372RC-EHFP- - - - PDUM2172RC-EHFP- - - -	executive "u" unit	104	72	29	class 125 cwt 680 lb cu ft 82	2,577.47 W 2,126.67 P	2,750.06 W 2,264.30 P

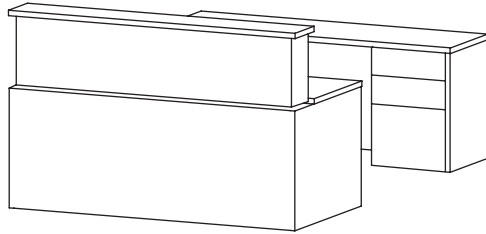

consists of:	d	w	h	quantity
PDD2372LCFP/PDD2172LCFP single pedestal desk left cpu pedestal	36	72	29	1
B2348-EH/B2148-EH bridge with open kneespace	20	48	29	1
C2372R-FP/C2172R-FP single pedestal credenza right box/box/file pedestal	20	72	29	1

model number	description	d	w	h	freight	net \$ zone 1	net \$ zone 2
PDDM2372LC-EHFP- - - - PDDM2172LC-EHFP- - - -	executive "u" unit	104	72	29	class 125 cwt 680 lb cu ft 82	2,577.47 W 2,126.67 P	2,750.06 W 2,264.30 P

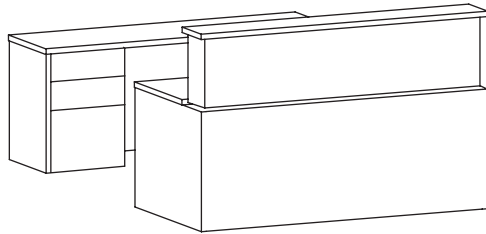

consists of:	d	w	h	quantity
PDD2372RCFP/PDD2172RCFP single pedestal desk right cpu pedestal	36	72	29	1
B2348-EH/B2148-EH bridge with open kneespace	20	48	29	1
C2372L-FP/C2172L-FP single pedestal credenza left box/box/file pedestal	20	72	29	1

model number	description	d	w	h	freight	net \$ zone 1	net \$ zone 2
PCUM2372RC-EHFP- - - - PCUM2172RC-EHFP- - - -	executive "u" unit	104	72	29	class 125 cwt 680 lb cu ft 82	2,577.47 W 2,126.67 P	2,750.06 W 2,264.30 P

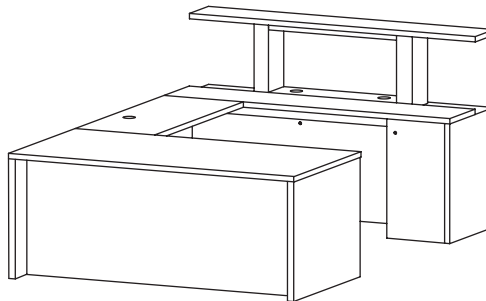

consists of:	d	w	h	quantity
D2372L-FP/D2172L-FP single pedestal desk left file/file pedestal	36	72	29	1
B2348-EH/B2148-EH bridge with open kneespace	20	48	29	1
PCC2372RCFP/PCC2172RCFP single pedestal credenza right cpu pedestal	20	72	29	1

top **P** laminate top
W veneer top

bridges custom length bridge sizes are available up to 65" with the grain direction running lengthwise (opposite the desk grain), add \$150.88 net and specify length.

edge





model number	description	d	w	h	freight	net \$ zone 1	net \$ zone 2
PCUM2372LC-EHFP- - - - PCUM2172LC-EHFP- - - -	executive "u" unit	104	72	29	class 125 cwt 680 lb cu ft 82	2,577.47 W 2,126.67 P	2,750.06 W 2,264.30 P

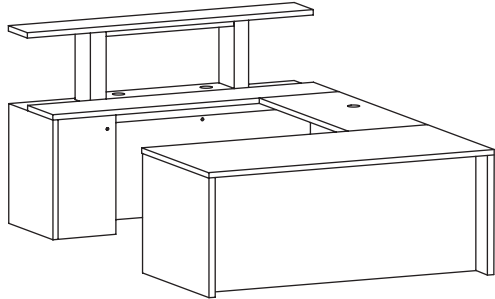

consists of:		d	w	h	quantity
D2372R-FP/D2172R-FP single pedestal desk right file/file pedestal	36	72	29	1	
		APPROACH: 7"			
		KNEESPACE: 36"			
B2348-EH/B2148-EH bridge with open kneespace	20	48	29	1	
		KNEESPACE: 48"			
PCC2372LCFP/PCC2172LCFP single pedestal credenza left cpu pedestal	20	72	29	1	
		KNEESPACE: 32"			

model number	description	d	w	h	freight	net \$ zone 1	net \$ zone 2
PDUM2366RC-EHFP- - - - PDUM2166RC-EHFP- - - -	executive "u" unit	104	66	29	class 125 cwt 670 lb cu ft 77	2,458.61 W 2,058.96 P	2,622.00 W 2,191.44 P

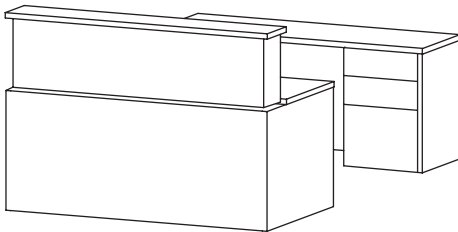

consists of:		d	w	h	quantity
PDD2366LCFP/PDD2166LCFP single pedestal desk left cpu pedestal	36	66	29	1	
		KNEESPACE: 30"			
B2348-EH/B2148-EH bridge with open kneespace	20	48	29	1	
		KNEESPACE: 48"			
C2366R-FP/C2166R-FP single pedestal credenza right box/box/file pedestal	20	66	29	1	
		KNEESPACE: 26"			

model number	description	d	w	h	freight	net \$ zone 1	net \$ zone 2
PDUM2366LC-EHFP- - - - PDUM2166LC-EHFP- - - -	executive "u" unit	104	66	29	class 125 cwt 670 lb cu ft 77	2,458.61 W 2,058.96 P	2,622.00 W 2,191.44 P

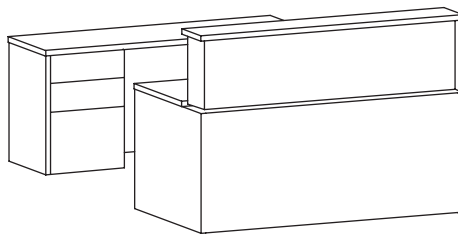

consists of:		d	w	h	quantity
PDD2366RCFP/PDD2166RCFP single pedestal desk right cpu pedestal	36	66	29	1	
		KNEESPACE: 30"			
B2348-EH/B2148-EH bridge with open kneespace	20	48	29	1	
		KNEESPACE: 48"			
C2366L-FP/C2166L-FP single pedestal credenza left box/box/file pedestal	20	66	29	1	
		KNEESPACE: 26"			

laminated
tops only

3L-P	walnut
4L-P	dark mahogany on walnut
25M-P	dark mahogany on walnut
25C-P	cherry on walnut
25B-P	ebony on walnut
2ML-P	natural maple
3ML-P	light maple
4ML-P	medium maple
5ML-P	cherry on maple
6LC-P	light cherry on cherry
7MC-P	medium cherry on cherry
8DC-P	dark cherry on cherry

veneer
top and
chassis
finish

3L-W	walnut
2KL-W	walnut
4L-W	dark mahogany on walnut
25M-W	dark mahogany on walnut
25B-W	ebony on walnut
25C-W	cherry on walnut
2ML-W	natural maple
3ML-W	light maple
4ML-W	medium maple
5ML-W	cherry on maple
6LC-W	light cherry on cherry

7MC-W	medium cherry on cherry
8DC-W	dark cherry on cherry
9BC-W	burgundy cherry on cherry

model number	description	d	w	h	freight	net \$ zone 1	net \$ zone 2
PCUM2366RC-EHFP- - - - PCUM2166RC-EHFP- - - -	executive "u" unit	104	66	29	class 125 cwt 670 lb cu ft 77	2,458.61 W 2,058.96 P	2,622.00 W 2,191.44 P

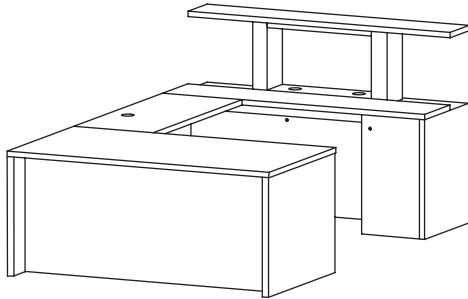

consists of:		d	w	h	quantity
D2366L-FP/D2166L-FP single pedestal desk left file/file pedestal	36	66	29	1	
		APPROACH: 7" KNEESPACE: 30"			
B2348-EH/B2148-EH bridge with open kneespace	20	48	29	1	
		KNEESPACE: 48"			
PCC2366RCFP/PCC2166RCFP single pedestal credenza right cpu pedestal	24	66	29	1	
		KNEESPACE: 26"			

model number	description	d	w	h	freight	net \$ zone 1	net \$ zone 2
PCUM2366LC-EHFP- - - - PCUM2166LC-EHFP- - - -	executive "u" unit	104	66	29	class 125 cwt 670 lb cu ft 77	2,458.61 W 2,058.96 P	2,622.00 W 2,191.44 P

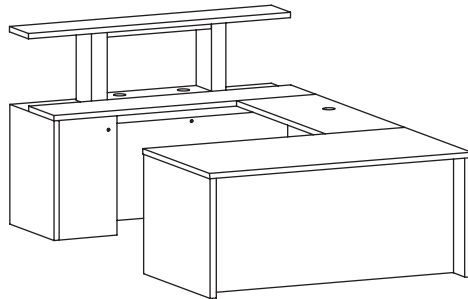

consists of:		d	w	h	quantity
D2366R-FP/D2166R-FP single pedestal desk right file/file pedestal	36	66	29	1	
		APPROACH: 7" KNEESPACE: 30"			
B2348-EH/B2148-EH bridge with open kneespace	20	48	29	1	
		KNEESPACE: 48"			
PCC2366LCFP/PCC2166LCFP single pedestal credenza left cpu pedestal	24	66	29	1	
		KNEESPACE: 26"			

model number	description	d	w	h	freight	net \$ zone 1	net \$ zone 2
PDUM236630RC-EHFP - - - PDUM216630RC-EHFP - - -	executive "u" unit	98	66	29	class 125 cwt 660 lb cu ft 69	2,410.40 W 1,919.12 P	2,571.22 W 1,966.22 P

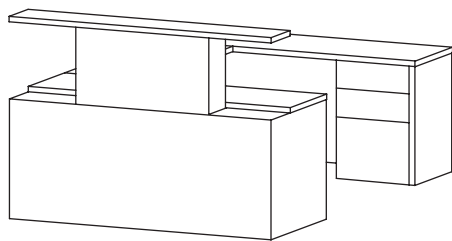

consists of:		d	w	h	quantity
PDD236630LCFP/PDD216630LCFP single pedestal desk left cpu pedestal	30	66	29	1	
		KNEESPACE: 30"			
B2348-EH/B2148-EH bridge with open kneespace	20	48	29	1	
		KNEESPACE: 48"			
C2366R-FP/C2166R-FP single pedestal credenza right box/box/file pedestal	20	66	29	1	
		KNEESPACE: 26"			

top P laminate top veneer top **bridges** custom length bridge sizes are available up to 65" with the grain direction running lengthwise (opposite the desk grain), add \$150.88 net and specify length.

edge





model number	description	d	w	h	freight	net \$ zone 1	net \$ zone 2
PDUM236630LC-EHFP- - - - - PDUM216630LC-EHFP- - - - -	executive "u" unit	98	66	29	class 125 cwt 660 lb cu ft 69	2,410.40 W 1,919.12 P	2,571.22 W 1,966.22 P

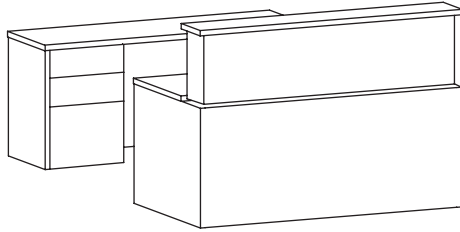

consists of:		d	w	h	quantity
PDD236630RCFP/PDD216630RCFP single pedestal desk right cpu pedestal	30	66	29	1	
B2348-EH/B2148-EH bridge with open kneespace	20	48	29	1	
C2366L-FP/C2166L-FP single pedestal credenza left box/box/file pedestal	20	66	29	1	

model number	description	d	w	h	freight	net \$ zone 1	net \$ zone 2
PCUM236630RC-EHFP - - - - PCUM216630RC-EHFP - - - -	executive "u" unit	98	66	29	class 125 cwt 660 lb cu ft 77	2,410.40 W 1,919.12 P	2,571.22 W 1,966.22 P

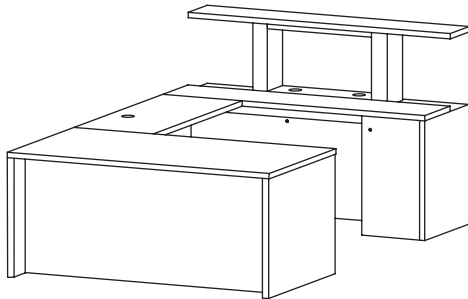

consists of:		d	w	h	quantity
D236630L-FP/D216630L-FP single pedestal desk left file/file pedestal	30	66	29	1	
B2348-EH/B2148-EH bridge with open kneespace	20	48	29	1	
PCC2366RCFP/PCC2166RCFP single pedestal credenza right cpu pedestal	20	66	29	1	

model number	description	d	w	h	freight	net \$ zone 1	net \$ zone 2
PCUM236630LC-EHFP - - - - PCUM216630LC-EHFP - - - -	executive "u" unit	98	66	29	class 125 cwt 660 lb cu ft 77	2,410.40 W 1,919.12 P	2,571.22 W 1,966.22 P

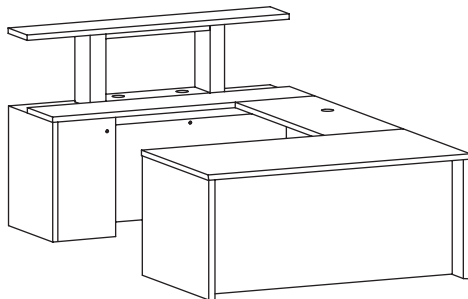

consists of:		d	w	h	quantity
D236630R-FP/D216630R-FP single pedestal desk right file/file pedestal	30	66	29	1	
B2348-EH/B2148-EH bridge with open kneespace	20	48	29	1	
PCC2366LCFP/PCC2166LCFP single pedestal credenza left cpu pedestal	20	66	29	1	

laminates	tops only
3L-P	walnut
4L-P	dark mahogany on walnut
25M-P	mahogany on walnut
25C-P	cherry on walnut
25B-P	ebony on walnut
2ML-P	natural maple
3ML-P	light maple
4ML-P	medium maple
5ML-P	cherry on maple
6LC-P	light cherry on cherry
7MC-P	medium cherry on cherry
8DC-P	dark cherry on cherry

veneers	top and chassis finish
3L-W	walnut
2KL-W	walnut
4L-W	dark mahogany on walnut
25M-W	mahogany on walnut
25B-W	ebony on walnut
25C-W	cherry on walnut
2ML-W	natural maple
3ML-W	light maple
4ML-W	medium maple
5ML-W	cherry on maple
6LC-W	light cherry on cherry

7MC-W	medium cherry on cherry
8DC-W	dark cherry on cherry
9BC-W	burgundy cherry on cherry